



I.P.F.

**INDUSTRIAL
PIONEERS
FARAYAND**

*Engineering & Fabrication in
Chemical, Petrochemical and
Pharmaceutical Industries*

Address: Unit 7, No8, 1st Kosar St., Tohid Sq., Tehran, Iran
Tel : (98) - (21) - (66922542,66591346)
Fax: (98) - (21) - (66423489)

URL: www.ipfarayand.com

Ò-Mail : Info @ ipfarayand.com



- *Mother Company Introduction*

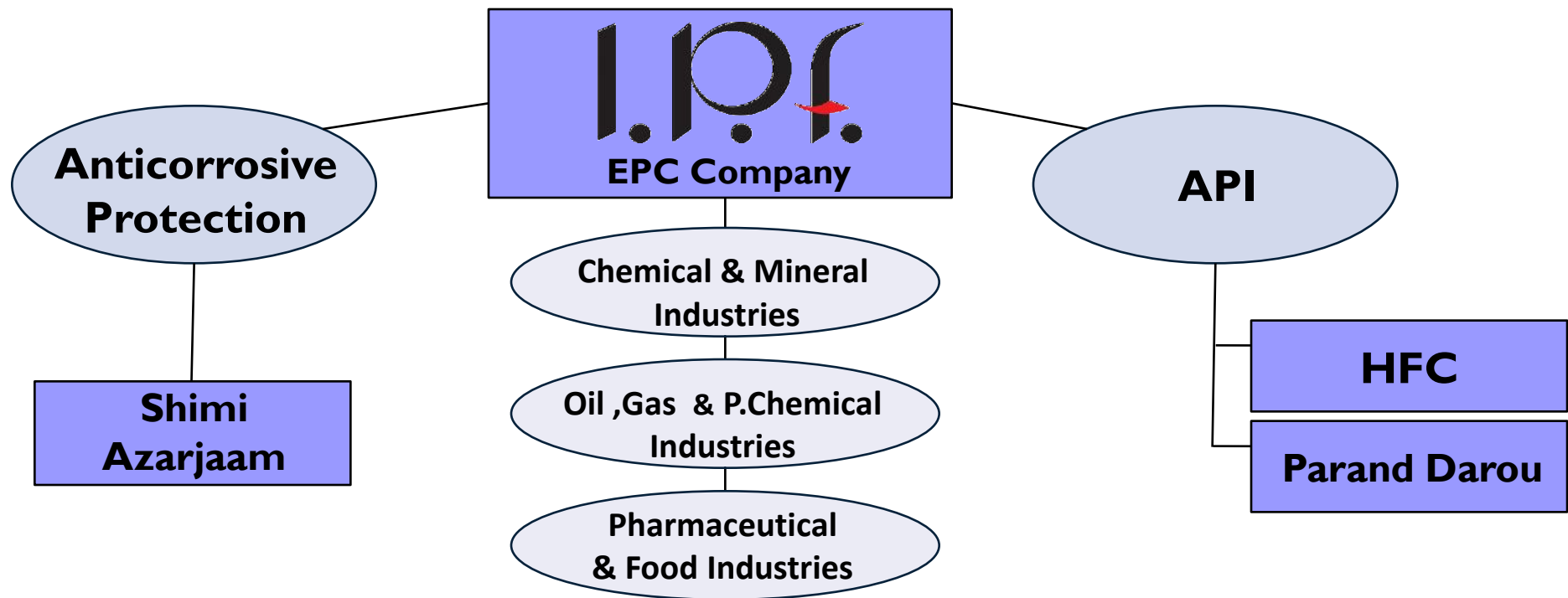

 Company

 Industrial fields of activity



Company Introduction

I.P.F. was established in 1990 as a company for fabricating of equipment for chemical and pharmaceutical industries.

It was expanded very rapidly and it's engineering section activated.

Now the company takes full advantages of process, mechanical, instrument, Electrical, and civil divisions.



Company Introduction

Also fully equipped fabricating workshop is tightly connected to the engineering section.

IPF Co. by obtaining the EPC certificate grade 2 for industry from planning management organization has tried to increase customer satisfaction.

For the time being more than 250 persons are working in IPF and their affiliate companies in Engineering department, workshop and in the form of executive team of projects.





Chemical & Mineral Industry

Petroleum & Gas Industry

Pharmaceutical Industry

Anticorrosive Protection

- ❑ **Consultancy**
- ❑ **Engineering**
- ❑ **Technology-Based Contracting**
- ❑ **General Contracting**
- ❑ **Overseas Services**
- ❑ **Export of Plant & Equipments**



The Company Capabilities

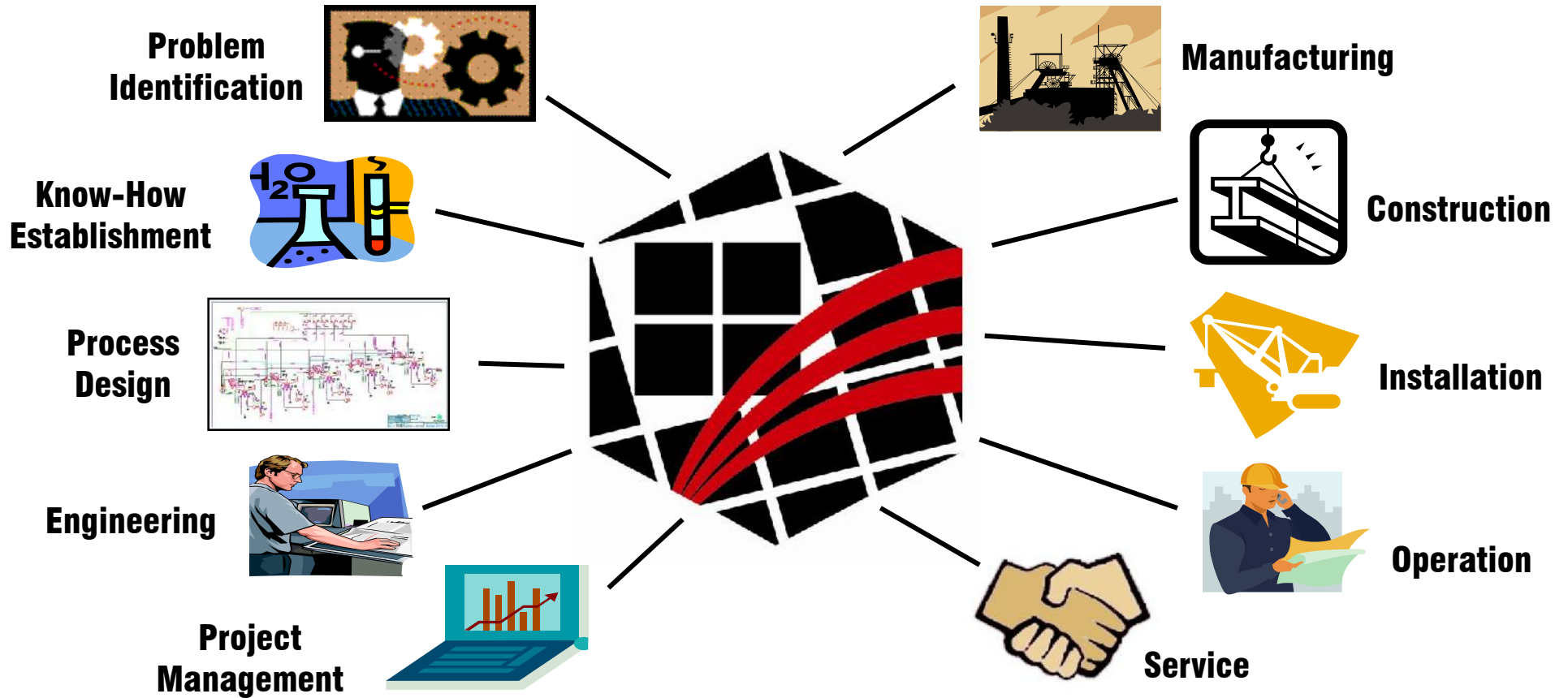

Company Departments

■ *Engineering Unit ; Basic & Detail Engineering*

- Process
- Mechanical
- Electrical
- Control & Instrumentation
- Civil

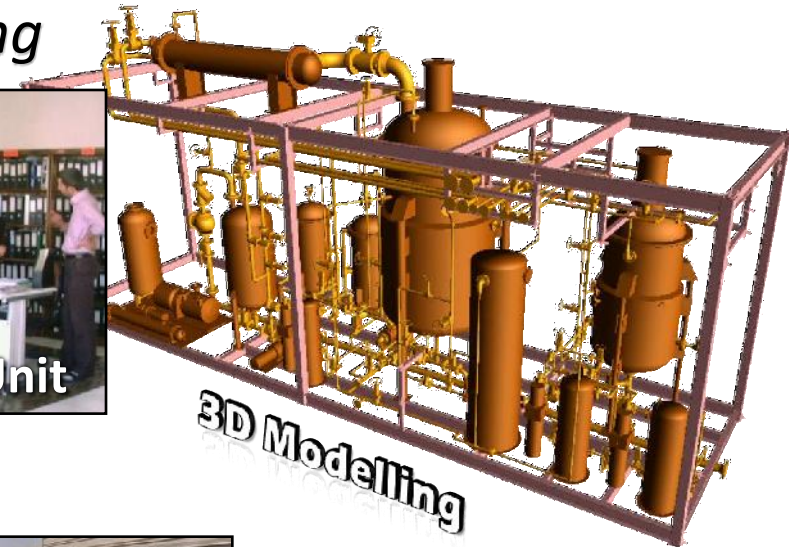

■ *Construction & Installation Unit*

- Equipment Fabricating
- Erection & Installation
- Piping & Caballing





Company Departments

➤ Process

- Basic design
- Block flow diagram / PFD / P&ID
- Detail engineering
- Process optimization
- Laboratory test methods
- Equipments specification

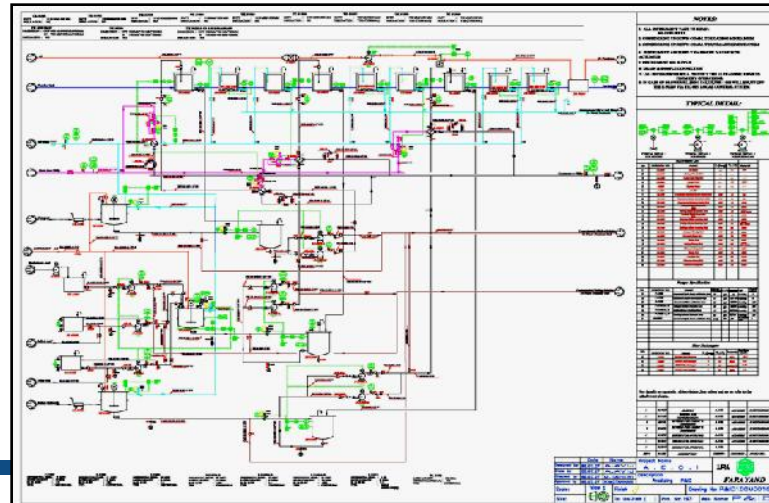

P&ID Design

Process

Crushing /
Milling

Leaching /
Reaction

Sedimentation /
Thickening

Adsorption /
Desorption

Evaporation /
Crystallization

Drying



➤ Process

Agitator Program

File Edit Run Help

D(Impeller Diameter):	0.4	[m]
W(reactor Width):	0.00	[m]
Nb(Buttles Number):	4	
J(Buttles Width):	0.1	[m]
All(Distance to Tank surface):	0.03	[m]
Bt(Distance to Bottom Of Tank):	0.04	[m]
N(Angular Speed):	25.449	[rpm]
Pe(Taylors Number):	1562.322	
Nq(Pumping Number):	0.62	
P(Power)	0	[kw]
d(Shaft Diameter):	0.578	[mm]
Uo(Unit Thermal Conductance):	432.526	[KJ/m ² .k]
A(Jacket Heat Transferring Area):	5570.060	[m ²]
Impeller Type :	Pitched Blade	
C1(Distance Between Impeller And Tank):	None	[m]
Motor:	0.06	[kw]
Imp_Num(Number Of Impellers):	1	
Ds_Low(Dis. Bet. Lower Imp. & Tank Bot.):	0.433	[m]
Ds_Up(Dis. Bet. Upper Imp. & Tank Top):	None	[m]
Np(Power Number):	1.4	

Agitator Design Software
Created by I.P.Farayand

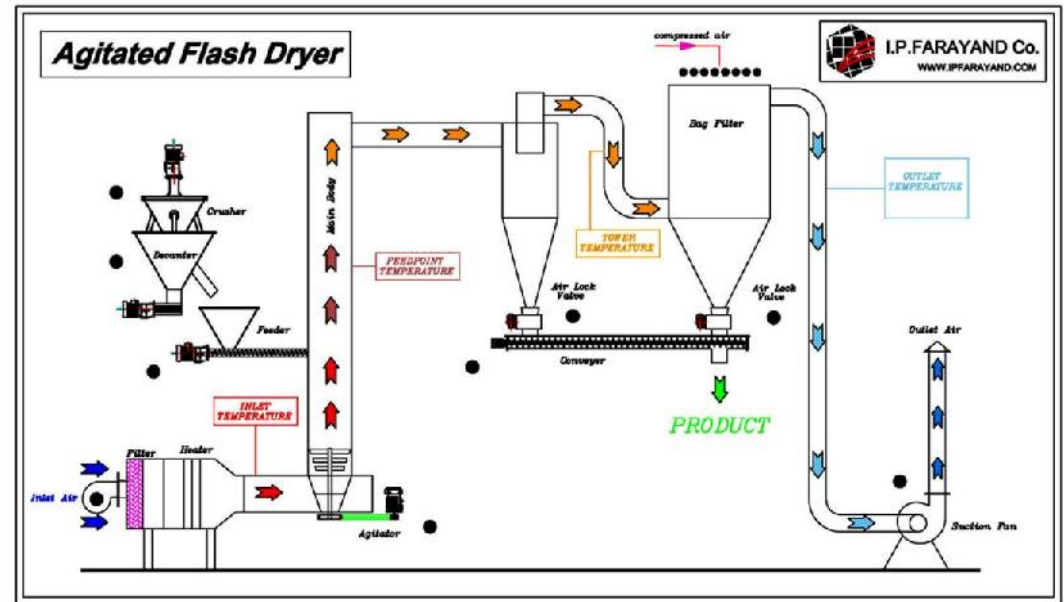

Dryer Flow Diagram



➤ Mechanic

Standard and code base calculation for Static & dynamic Equipments

Pressure Vessel / Heat Exchanger / Dryer / Column Design

Stress Analysis

Basic / Detail / Workshop drawings

Piping Design / 3D Drawings / ISO Drawings / MTO

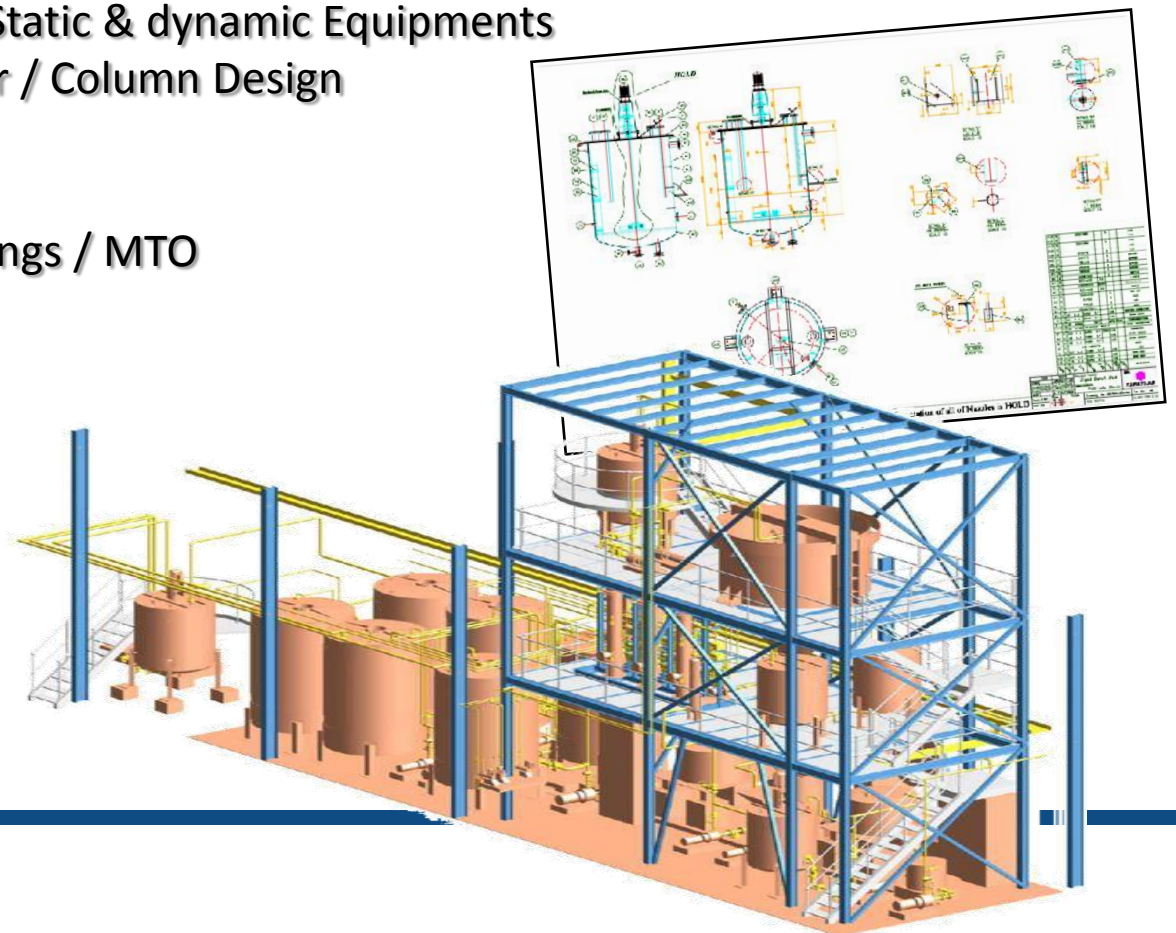
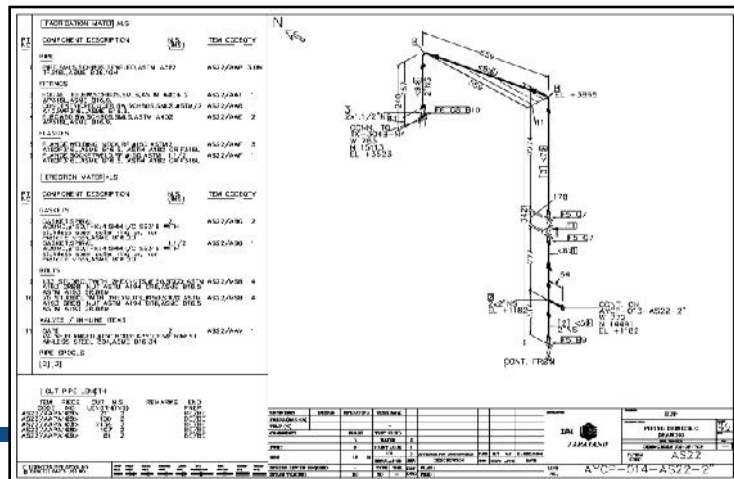



➤ Electrical, Control & Instrumentation

Load list preparation

MCE & Cables Calculation

Panel design

General arrangement & Root design

Design of lightning & fire fighting in plant

Precommissioning & Commissioning of plant

FAT & SAT Tests

Control system selection design & programming

Instrument selection and control loop design





➤ Electrical, Control & Instrumentation

There is a standalone department for process control & Automation in the company. Expert staff attended to some outstanding professors solve all problems in the field of process control of the projects.

New technologies and foundations such as DCS, FIELDBUS, PROFIBUS, PROFANED, etc. are used along with famous brands such as Siemens PCS7, Omron, Schneider and so on.

Our main target in this discipline is to achieve the best and uniform quality of the products with the most smooth and trouble-free operations to Manage all process control system.

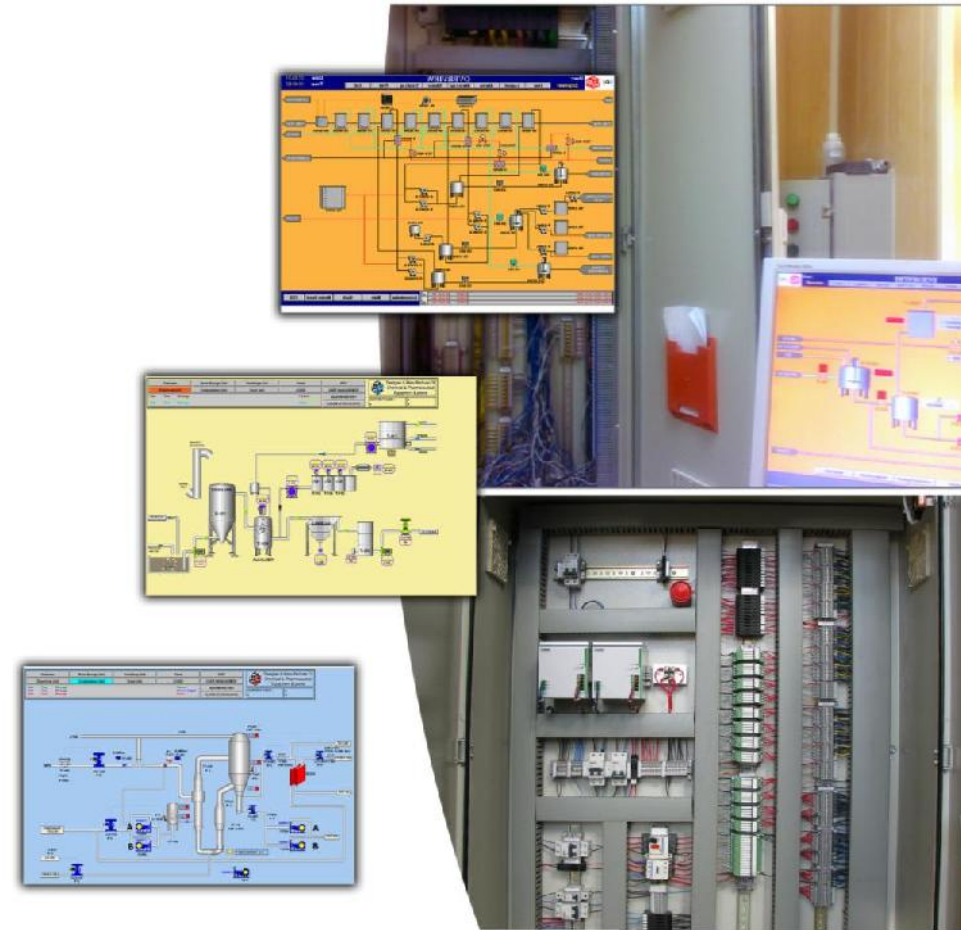

Company Departments

- Civil
 - Concrete / Steel Structure Design
 - Structure Design for Static & Dynamic loads
 - Layout / Site Plant / Architectural Design
 - Equipment Foundation / Pipe Racks / Supports
 - Civil Construction
 - Clean Room Design & Construction with GMP Standard

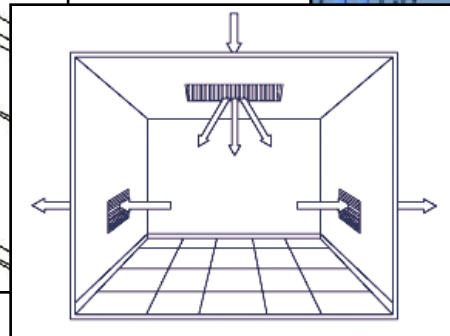
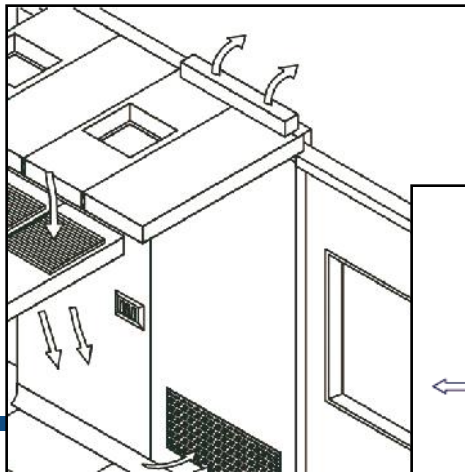
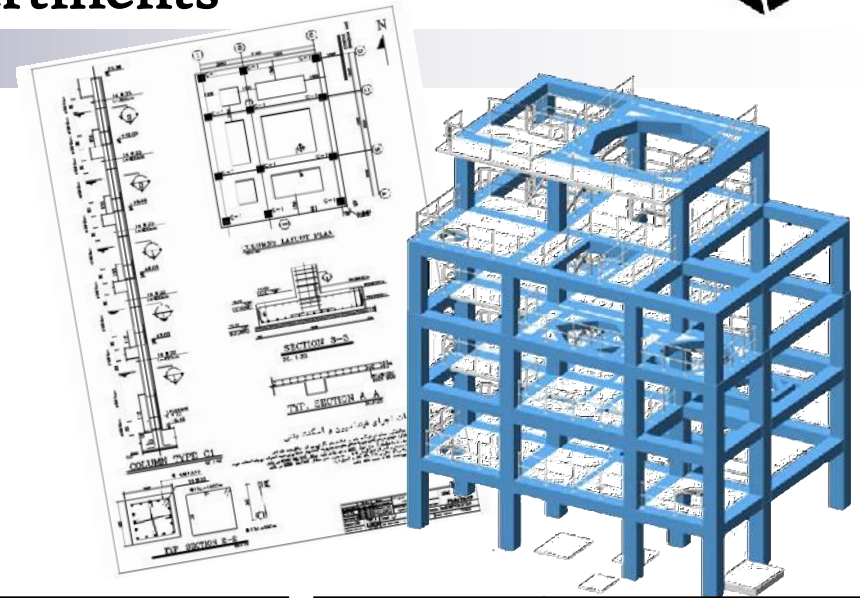

■ *Research & Development*

- Basic Research
- Process Development
- Laboratory & QC
- Pilot Plant Facilities
- Design Confirmation
- Economic Research



**Instrumental Analysis
Laboratory**

■ *Procurement*

- Procurement Engineering
- Local & Foreign Supply
- L/C Opening
- Contracting
- Custom Clearance



I.P.F. Factory Warehouse

Company Departments

■ Commercial

■ Import

- Sourcing
- Agency
- Contracting

■ Export

- Marketing
- Representation
- Re-Export

■ Services

- L/C & T/T Facilities
- Business Consultancy
- Exhibition

■ Overseas Offices

- Turkey
- China
- U.K.
- Canada





Organization Chart

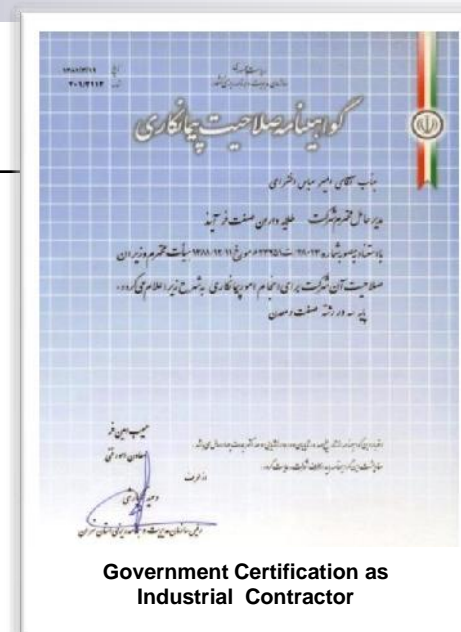
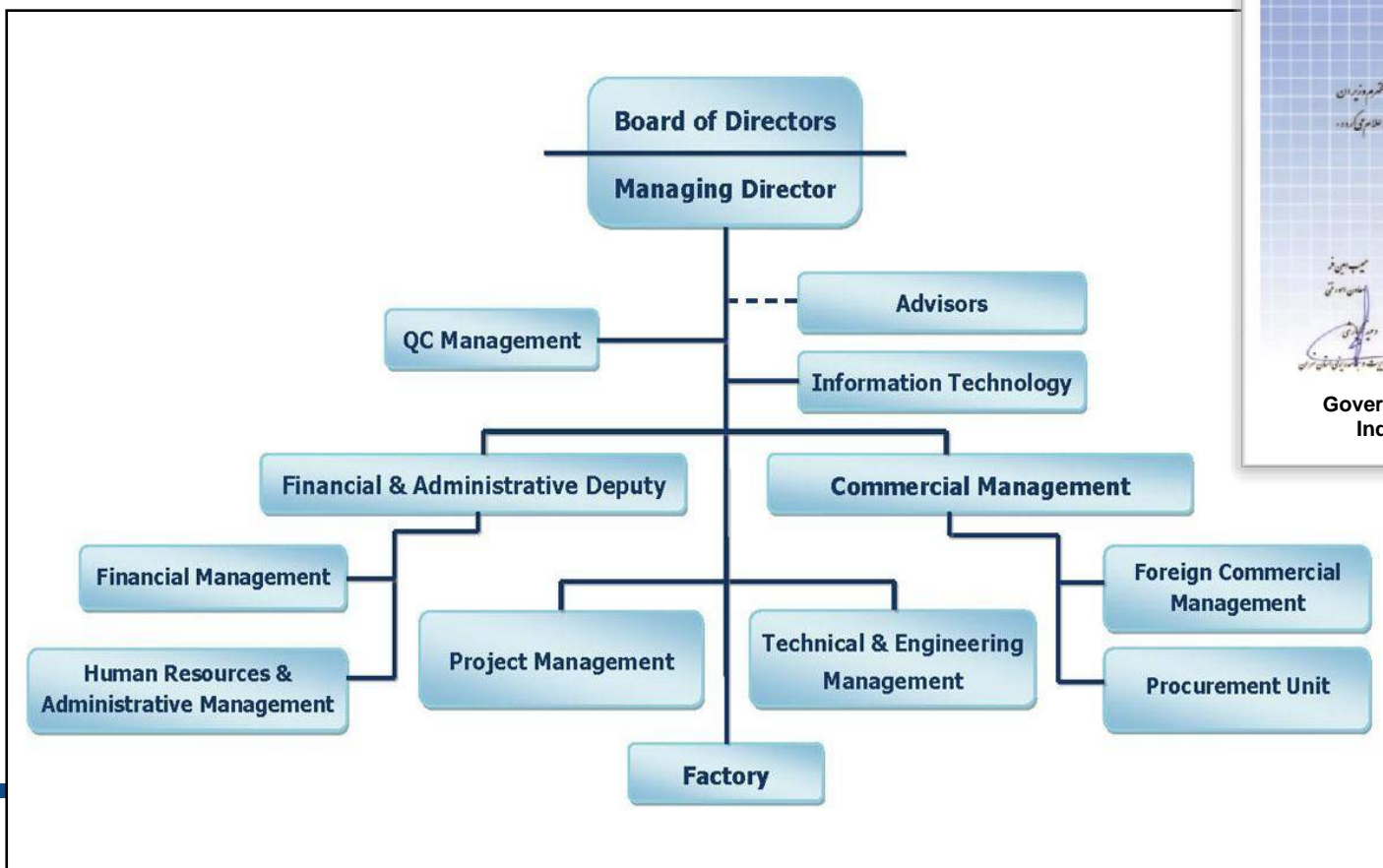



■ Salt Purification Projects:

- Sadafe Sepid
- Iran Salt
- Sepid Daneh
- Azar Sepide Bolur
- Namakal Salt





- Gold Processing Plant:



- CCD Thickeners for Leaching process:



- Aerated Autoclave Concrete (AAC) Machinery & Plant:

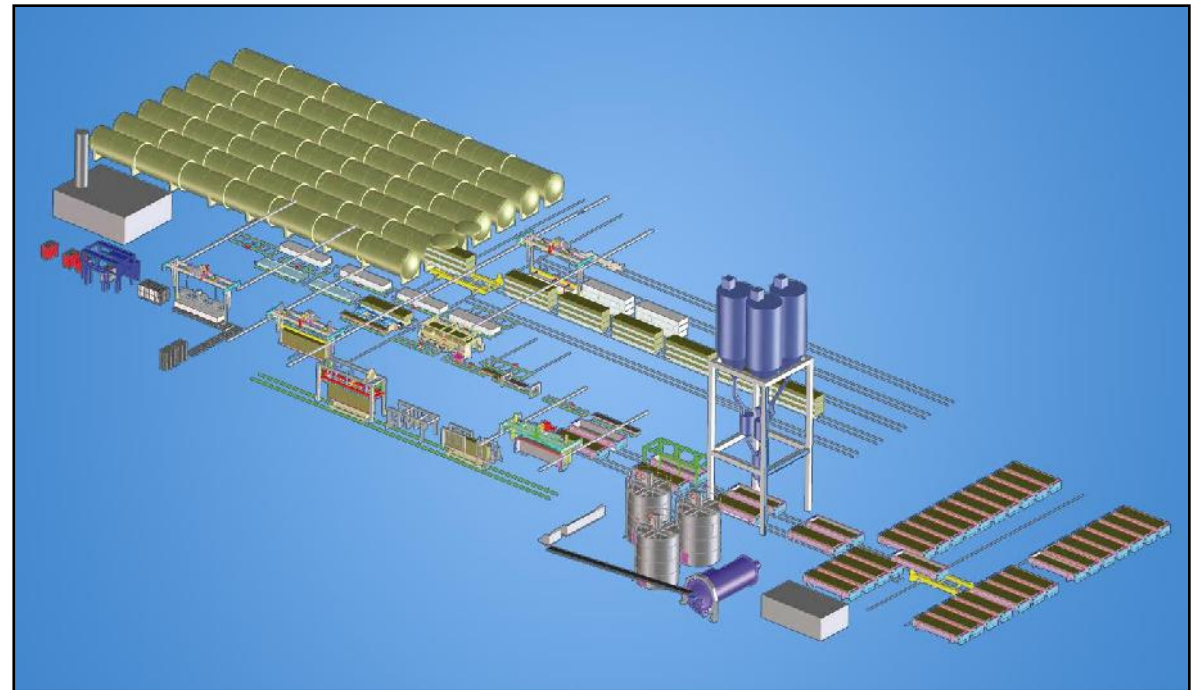



- Chemical Injection Packages:
 - Phases 6,7,8 of South Pars Gas Field
 - Salman Oil Platform
 - Sarcheshmeh Copper Industries Plant
 - Shiraz Petrochemical Co.
 - Iranian Offshore Oil Co. (Sirri Island)





- High Pressure Reactor & Shell & Tube Heat Exchangers:
 - Research institute Of Petroleum Industry (RIPI)



- Tripods:
 - P.E.D.Co.



References: Pharmaceutical Industry

- Magnesium hydroxide Gel

- Behansar

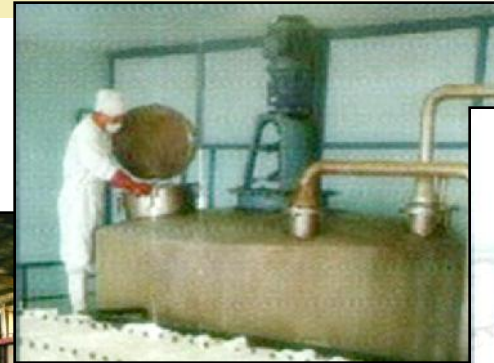

- Salicylic Acid Project:

- Faran Shimi



- Sodium Acetate Project:

- Neshat Daroo

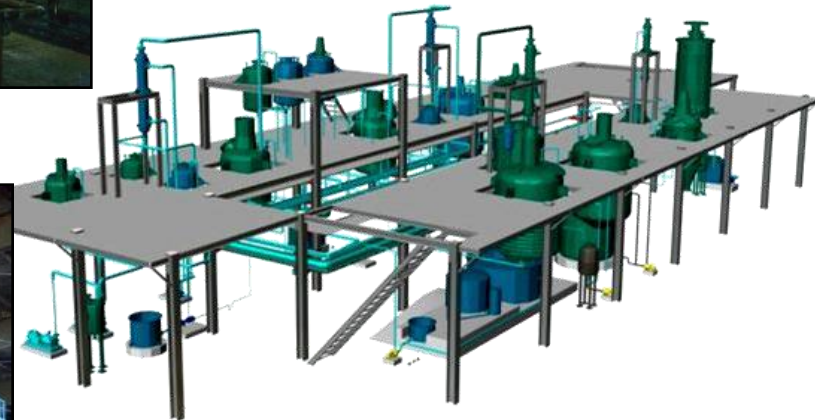



References:
Pharmaceutical Industry



- Hackim Farayand Chemi Co.





■ Parand Darou Co.





- Glass
- PTFE
- ECTFE
- PFA
- FEP

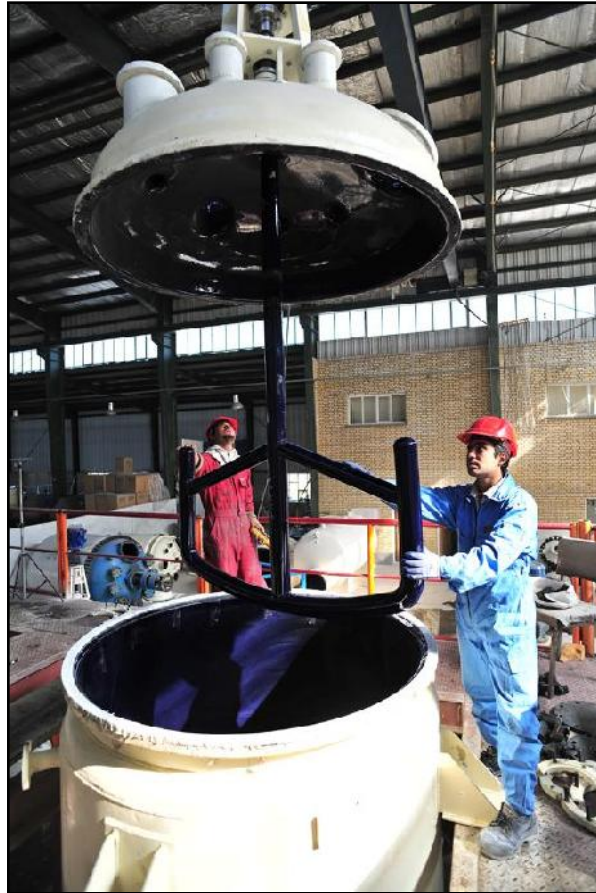

Overseas Projects

- We provide professional and dedicated services in the Middle East Region, Central Asia & Other Countries.

- Fermenter:

- Dr. Bluhm GmbH.
(Export to Germany)

- Iodic Salt Project:

- Afghanistan (UNICEF)

- ...



Equipments

■ During the last years we have carried out engineering, fabrication and installation in a wide range of equipments.

- Dryers
- Mixers
- Filters
- Chemical Injection Packages
- Crystallizers
- Reactors
- Pressure Vessels
- Bio Reactors
- WTP
- CPP

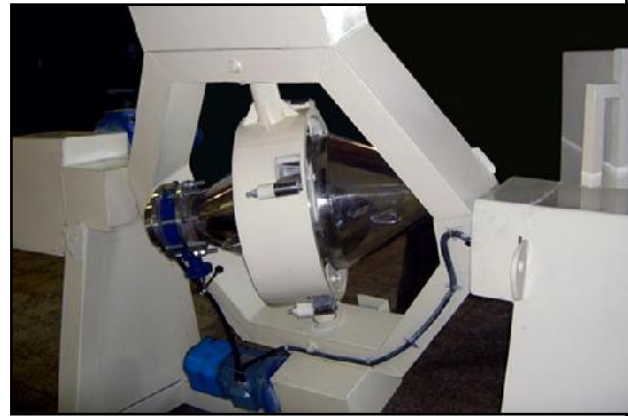









INDUSTRIAL PIONEERS FARAYAND

Are you looking for a reliable company?

Contact us:

URL: www.ipfarayand.com

E-Mail : info@ipfarayand.com

Address: Unit 7, No8, 1st Kosar St, Tohid Sq, Tehran, Iran

Tel : (98) - (21) - (66922542, 66591346)

Fax: (98) - (21) - (66423489)